

Custom Spark Arrestor Chimney Caps Quote Form



Date: _____ Customer Name: _____ Customer P.O. _____

Customer Address: _____

Phone: _____ Fax: _____ eMail: _____

Store Number: _____ Store Location: _____

1. Pick your style
2. Pick your finish
3. Give us your size

1

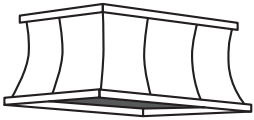

SIENA

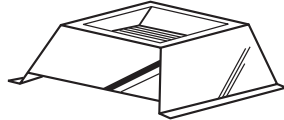

PYRAMID

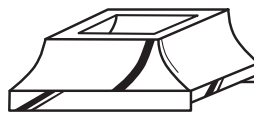

SWEPT PYRAMID



GABLE

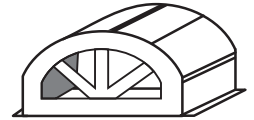

SUNBURST

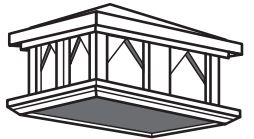

COUNTRY FRENCH

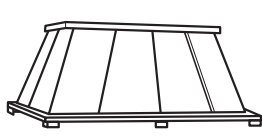

INCA

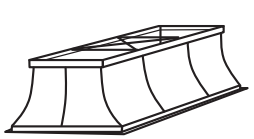

MILANO



HALF ROUND

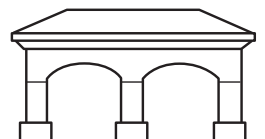

HILLCREST

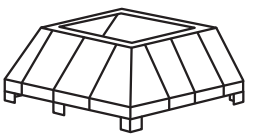

STANTON

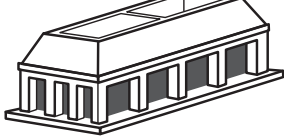

FEDERAL

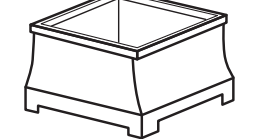

FRENCH



CLOSED HALF ROUND



VAULTED ARCH

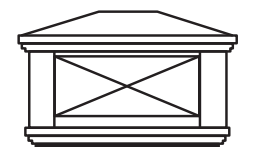

HACIENDA

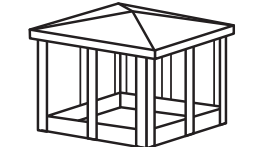

COTTAGE



DOG HOUSE

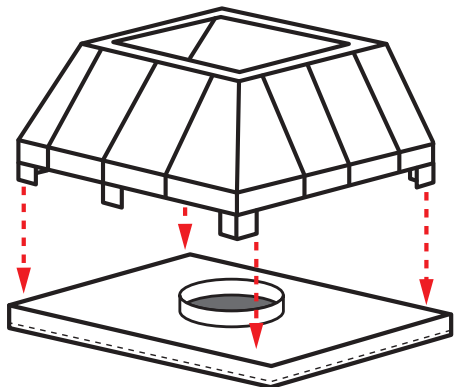

CUSTOM MOUNTING FLANGE INCLUDED.

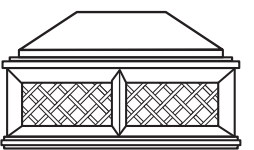

TUSCAN

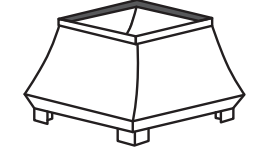

PAGODA



TEAR DROP

- 2** Galvanized Steel Bonderized Steel Galvalume Stainless Steel Copper

3 Outside dimensions of your chimney flue: _____ x _____ (inches)

CONSTRUCTION METALS INC.

A GIBRALTAR INDUSTRIES COMPANY

FAX TO: 909-390-9877